

**HONDA**  
**MESIN SERBAGUNA**

**WB20XN / WB30XN**  
**WL20XN / WL30XN**

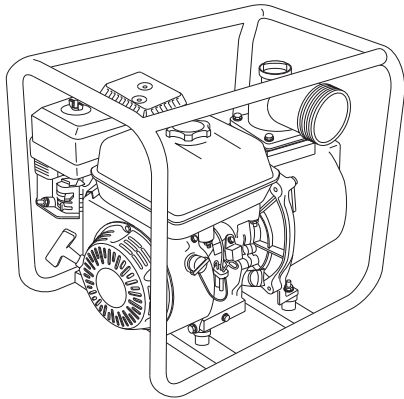

## BUKU PETUNJUK PEMILIK

©PT Honda Power Products Production 2015  
00X4H-YH8-6000

### Didistribusikan oleh:

PT Honda Power Product Indonesia  
Jl. Iskandar Muda No 97  
Jakarta-12240, Indonesia

Tel : 021-7294450/58

Fax : 021-7294452/56

Web site : [www.hondapowerproducts.co.id](http://www.hondapowerproducts.co.id)

E-mail : [cs@hppi.co.id](mailto:cs@hppi.co.id)



## 1. KESELAMATAN UMUM

JANGAN GUNAKAN DI DALAM RUMAH

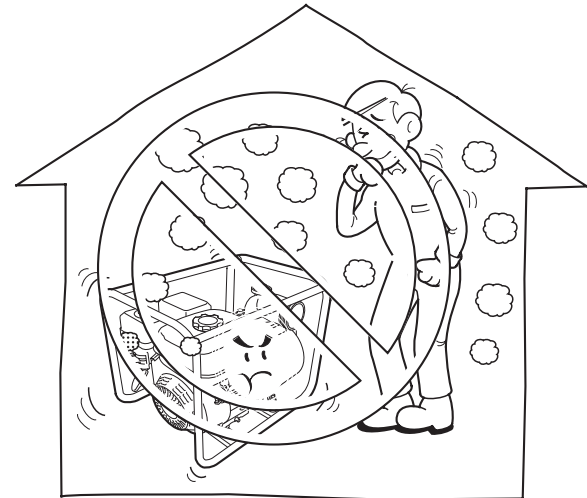

JAUHKAN DARI BAHAN-BAHAN MUDAH TERBAKAR  
LEBIH dari 1 meter

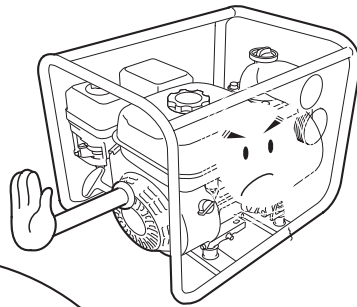

DILARANG MEROKOK



JANGAN TUMPAH

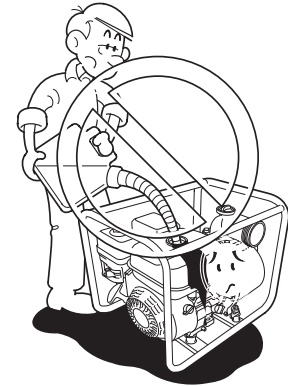

HENTIKAN MESIN

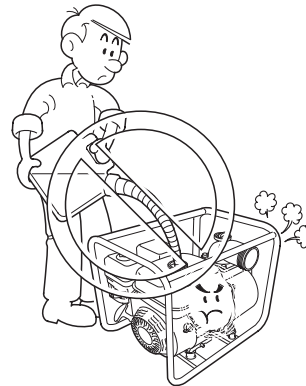

JAUHKAN DARI JANGKAUAN ANAK-ANAK

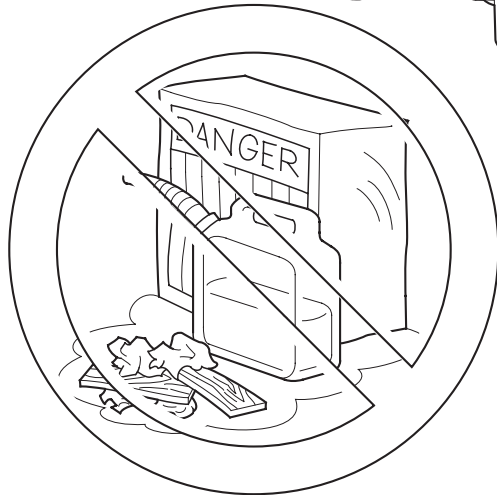
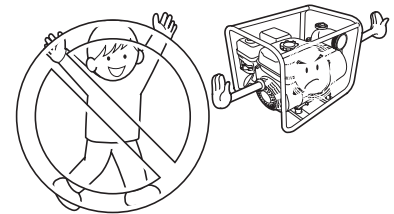

## 2. SPESIFIKASI

<b>DIMENSI</b>		
<b>MODEL</b>	<b>WB20XN</b>	<b>WB30XN</b>
Panjang keseluruhan	490 mm (19.3 in)	510 mm (20.1 in)
Lebar keseluruhan	385 mm (15.2 in)	385 mm (15.2 in)
Tinggi keseluruhan	410 mm (16.1 in)	435 mm (17.1 in)
Bobot kering	24 kg (53 lbs)	25 kg (55 lbs)
Bobot pengoperasian (termasuk gas, oli)	27 kg (60 lbs)	27 kg (60 lbs)
<b>MESIN</b>		
Model	GX160H1	
Tipe	4 stroke, overhead, single cylinder, inclined by 25°	
Displacement total	163 cm <sup>3</sup> (9.9 cu-in)	
Sistem pendingin	Forced Air	
Sistem pembakaran	Transistor Magneto Ignition	
Sistem penyalaan	Recoil Starter	
Kapasitas tangki bahan bakar	3.1 Liters	
<b>POMPA AIR</b>		
Total Diameter lubang hisap	50 mm (2.0 in)	80 mm (3 in)
Diameter lubang keluar	50 mm (2.0 in)	80 mm (3 in)
Total head Maksimum	Min. 32 m (105.6 ft)	Min. 23 m (75.9 ft)
Tinggi maksimum penghisapan	Min. 7.5 m (24.7ft)	Min. 7.5 m (24.7ft)
Kapasitas pengaliran maksimum	Min.670 Liter / min	Min. 1.100 Liter / min

<b>DIMENSI</b>		
<b>MODEL</b>	<b>WL20XN</b>	<b>WL30XN</b>
Panjang keseluruhan	490 mm (19.3 in)	510 mm (20.1 in)
Lebar keseluruhan	385 mm (15.2 in)	385 mm (15.2 in)
Tinggi keseluruhan	410 mm (16.1 in)	435 mm (17.1 in)
Bobot kering	24 kg (53 lbs)	25 kg (55 lbs)
Bobot pengoperasian (termasuk gas, oli)	27 kg (60 lbs)	27 kg (60 lbs)
<b>MESIN</b>		
Model	GP160H	
Tipe	4 stroke, overhead, single cylinder, inclined by 25°	
Displacement total	163 cm <sup>3</sup> (9.9 cu-in)	
Sistem pendingin	Forced Air	
Sistem pembakaran	Transistor Magneto Ignition	
Sistem penyalaan	Recoil Starter	
Kapasitas tangki bahan bakar	3.1 Liters	
<b>POMPA AIR</b>		
Total Diameter lubang hisap	50 mm (2.0 in)	80 mm (3 in)
Diameter lubang keluar	50 mm (2.0 in)	80 mm (3 in)
Total head Maksimum	Min. 32 m (105.6 ft)	Min. 23 m (75.9 ft)
Tinggi maksimum penghisapan	Min. 7.5 m (24.7ft)	Min. 7.5 m (24.7ft)
kapasitas pengaliran maksimum	Min.670 Liter / min	Min. 1.100 Liter / min

### 3. PEMERIKSAAN SEBELUM PENGGUNAAN

#### 1. KETINGGIAN OLI



PERHATIAN : Periksa mesin di permukaan rata dalam kondisi dimatikan.

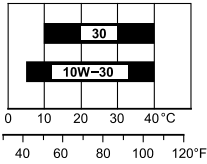

Jenis Oli yang direkomendasikan



**Honda Power Oil**  
4-STROKE MOTOR  
API SJ atau di atasnya

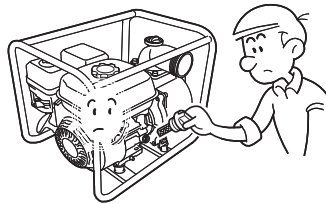

1. Periksa ketinggian oli.

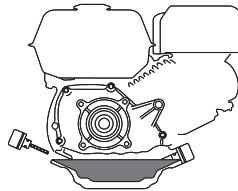

2. Jika ketinggian oli berkurang, isi oli hingga mencapai bagian atas

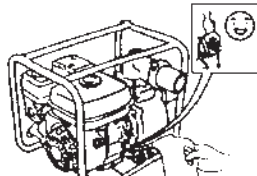

### 2. KETINGGIAN PERMUKAAN BAHAN BAKAR



1. Periksa ketinggian permukaan bahan bakar.

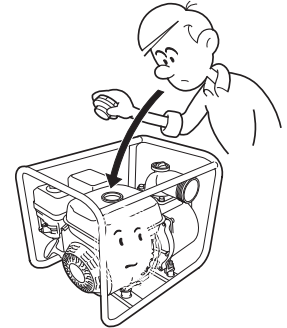

2. Jika ketinggian permukaan bahan bakar berkurang, isi hingga mencapai bahu saringan bahan bakar

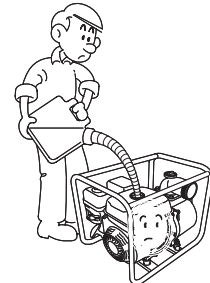

Gunakanlah bensin murni tanpa timbal dengan angka oktan (RON) 88 atau lebih.

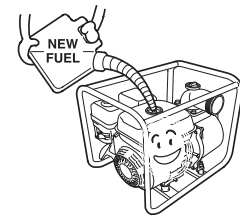
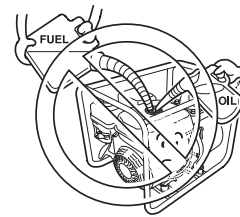

### 3. PEMBERSIH UDARA

1. Periksa kotoran di dalam elemen pembersih udara.



PENUTUP PEMBERSIH UDARA

ELEMEN PEMBERSIH UDARA

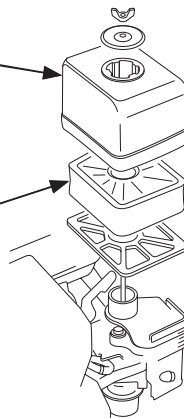

2. Bersihkan jika kotor (Baca halaman 22).

### 4. MEMANCING DENGAN AIR

1. Periksa apakah pompa terisi air.

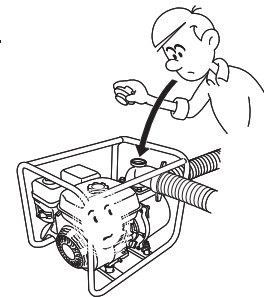

2. Jika kosong, isi dengan air

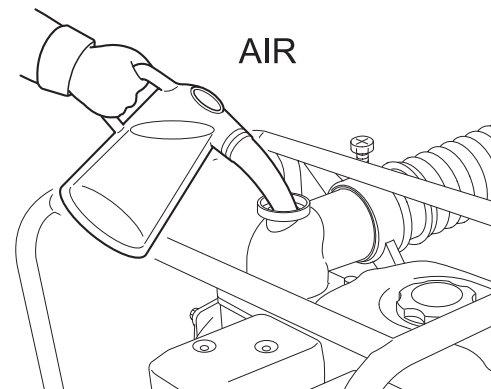

## 4. MENGHIDUPKAN MESIN

1. Putar katup bahan bakar ke posisi "ON"



2. Geser tuas gas sedikit ke kiri.



3. Putar tuas choke ke posisi tutup.



4. Putar saklar mesin ke posisi "ON"



5. Tarik perlahan gagang starter sampai terasa tertahan, lalu tarik dengan cepat.



6. Putar tuas choke ke posisi buka.



7. Atur tuas gas ke posisi yang diinginkan.



## 5. MEMATIKAN MESIN

1. Geser tuas gas sampai ke ujung kanan.

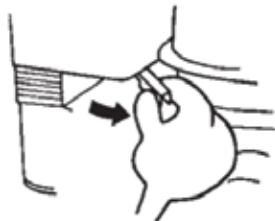

3. Geser katup bahan bakar ke posisi "OFF"

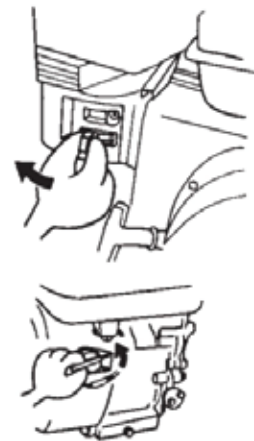

2. Putar saklar mesin ke posisi "OFF"

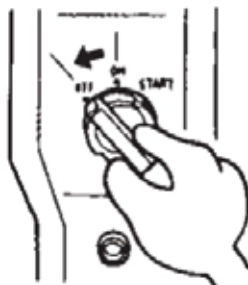



## 6. PEMELIHARAAN

### JADWAL PEMELIHARAAN

JADWAL SERVIS REGULER		Setiap kali dipakai	Bulan pertama atau 20 Jam	Setiap 3 bulan atau 50 Jam.	Setiap 6 bulan atau 100 Jam.	Setiap 1 tahun atau 300 Jam.
ITEM	Dilakukan pada setiap bulan yang ditentukan atau interval jam pemakaian mana yang lebih dulu.					
× Mesin	Periksa level-nya	○				
	Ganti		○			○
× Saringan udara	Periksa	○				
	Bersihkan			○ (1)		
× Busi	Periksa-Setel kembali				○	
× Spark arrester (part pilihan)	Periksa – Bersihkan				○	
× Jarak valve	Periksa – Setel kembali					●
× Filter dan tangki bahan bakar	Bersihkan					○ (1)
× Saluran bahan bakar	Periksa (Ganti bila perlu)	Setiap 2 tahun				
× Impeller	Pemeriksaan					○ (1)
× Jarak impeller	Pemeriksaan					○ (1)
× Inlet valve pompa	Pemeriksaan					○ (1)

- CATATAN:
- (1) Lakukan servis lebih sering bila digunakan di area berdebu.
    - Item tersebut sebaiknya diservis oleh dealer resmi Honda, meskipun pemiliknya memiliki peralatan yang tepat serta keahlian mesin.



Pemeriksaan



Penggantian



Pembersihan

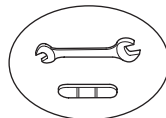

Pemeriksaan  
-Penyesuaian

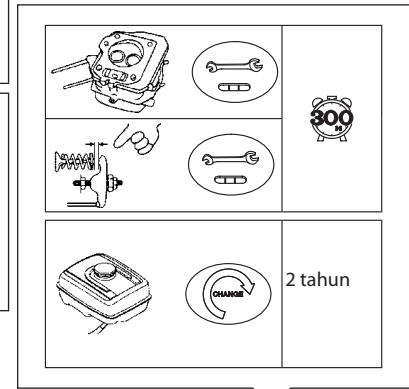
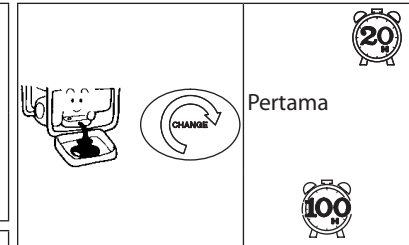
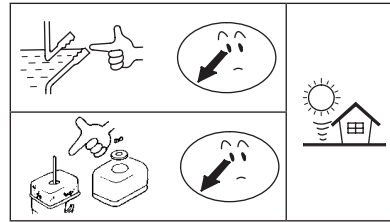

Kunjungi dealer resmi Honda.

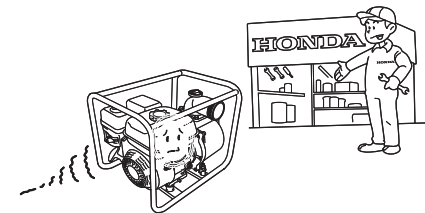

## 1. PENGGANTIAN OLI

1. Lepas tutup pengisian oli.
2. Lepas baut penguras oli dan kuras oli.

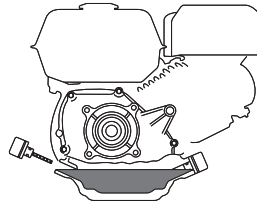
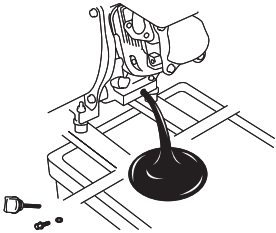

3. Kencangkan kembali baut penguras dan isi kembali oli hingga batas leher pengisian oli.

## 2. BUSI

1. Lepaskan busi.

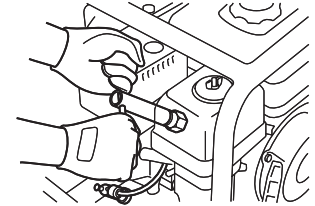

2. Bersihkan sisa pembakaran.

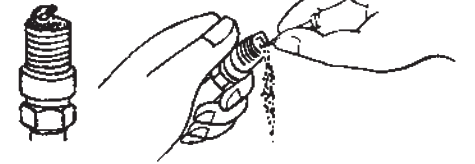

3. Ukur celah / kerenggan busi

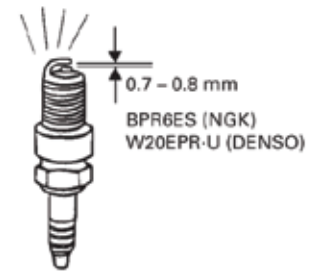

### 3. SARINGAN BAHAN BAKAR

1. Lepaskan cawan saringan.



2. Bersihkan cangkir saringan bahan bakar.



### 4. PEMBERSIH UDARA

1. Lepas penutup dan elemen pembersih udara.

2. Bersihkan elemen pembersih udara.

PENUTUP PEMBERSIH UDARA

ELEMEN PEMBERSIH UDARA.

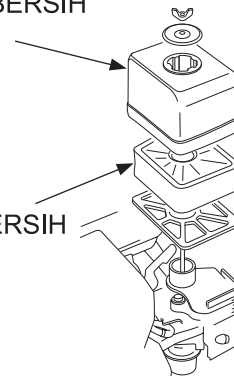

Cuci

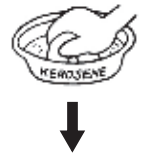

Rendam



Peras

## 7. PENYIMPANAN

1. Kuras tangki bahan bakar.

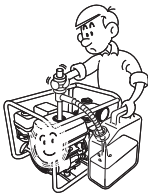

2. Kuras karburator.

SEALING WASHER  
BAUT PENGURAS



3. Lepas baut penguras dan kuras oli.

TUTUP PENGISIAN OLI/  
DIPSTICK

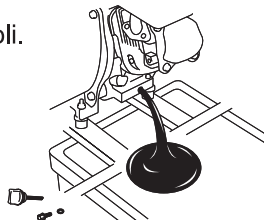

4. Kencangkan kembali baut penguras oli dan isi oli hingga batas leher pengisian oli.

KENCANGKAN BOUT

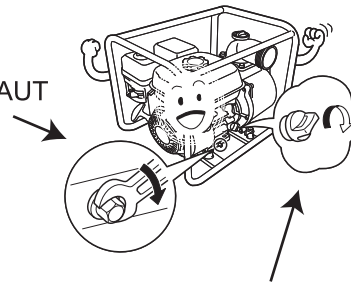

KENCANGKAN TUTUP PENGISI

5. Simpan mesin di tempat yang bersih.



## 8. PEMECAHAN MASALAH

### JIKA MESIN TIDAK HIDUP

1. Periksa bahan bakar.

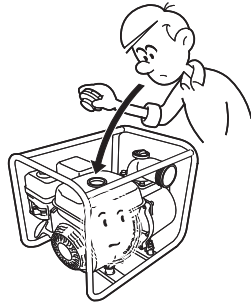

2. Periksa oli.

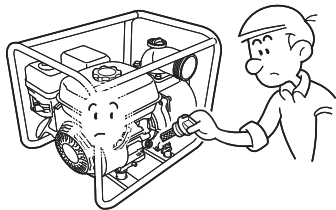

3. Hidupkan mesin setelah bahan bakar dan oli sudah diperiksa

4. Jika Mesin tidak Hidup, lepas dan periksa busi (Bersihkan Jika kotor dan atur jarak gap busi)

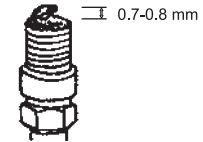

5. Jika Mesin tetap tidak Hidup, segera bawa ke dealer resmi Honda.



## JIKA POMPA TIDAK DAPAT MEMOMPA AIR

1. Periksa air pemancing.

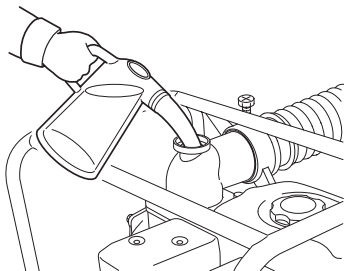

2. Periksa saringan.

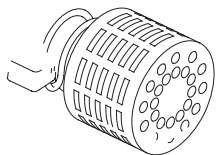

2.1. Apakah saringan tersumbat?

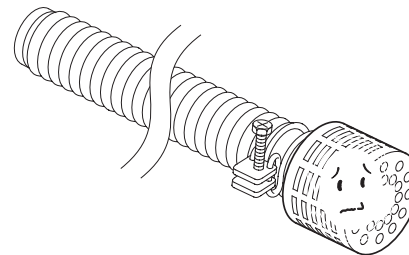

2.2. Apakah selangnya rusak?

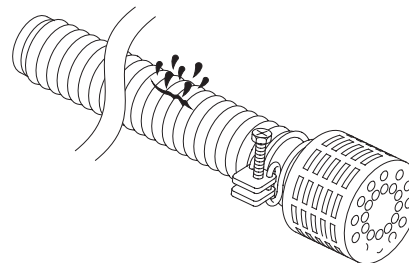

2.3. Apakah pengunci selang terpasang dengan baik?

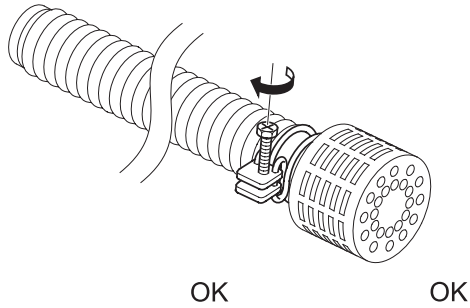

2.4. Apakah ujung hisap atau total head terlalu tinggi, sehingga daya hisapnya lemah?

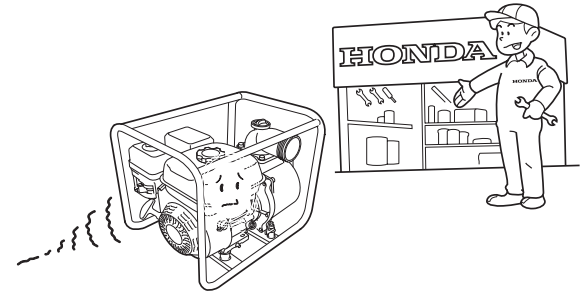

Bawa pompa ke dealer resmi Honda

